

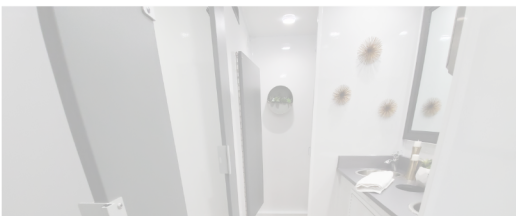

THE LAVATORY  
— NUMBER ONE AND TWO IN LUXURY MOBILE RESTROOMS —



# PRODUCT GUIDE

California Locations -  
(559) 382-0982 & (209) 202-3741

Arizona - (602) 598-1331

Utah - (801) 735-3009

[theLavatory.com](http://theLavatory.com)



# Contents

2 Station Luxury Restroom Trailer

ADA + 2 Restroom Trailer

5 Station Luxury Restroom Trailer

9 Station Restroom Trailer

ADA Shower & Restroom Combo

2 Station Shower & Restroom Combo

8 Station Private Shower Trailer

8 Station Laundry Trailer

# 2 Station Luxury Restroom Trailer

The **2 Station Restroom Trailer** is a great compact unit that fits well into most event space. We recommend using this size trailer perfect for events of 150 guests or less or for jobsites with 20 employees or less.



**Ask about our  
SPECIAL RATES  
for weekday  
& long term  
rentals!**

## STANDARD FEATURES

- **WOMEN'S** -1 toilet, 1 sink
- **MEN'S** - 1 toilet, 1 urinal, 1 sink
- Onboard water tank
- Equipped with AC/Heating
- White china toilets with foot flush
- Interior & Exterior LED Lights
- Self Leveling Stairs with Platforms & Railings
- Seamless Gel-coated Fiberglass Walls, Ceiling, and Subfloor
- Oversized Mirrors with Decorative Frames
- Stainless Steel Sinks
- Smart Touch Digital Thermostat

## SPECIFICATIONS

Number of Stations	Womens - 1, Mens - 1
Box Size	7' 4" x 11'
Length w/ tongue	17'
Width w/ Stairs	10' 7"
Height w/ AC	11' 4"
Fresh Water Tank	105 Gallons
Waste Tank	300 Gallons
Power Requirements	One dedicated 120 Volt-20 amp circuit within 100' of the trailer.
No. of AC Units	1

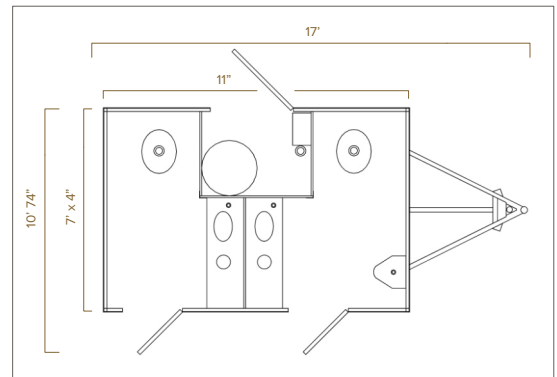

For information on how to reserve this trailer visit  
[theLavatory.com](http://theLavatory.com)

California Locations -  
(559) 382-0982 & (209) 202-3741

Arizona - (602) 598-1331  
Utah - (801) 735-3009



The **ADA + 2 Restroom Trailer** is designed specifically to meet the Americans with Disabilities Act, with ease of access for individuals in a wheelchair or elderly end users. We recommend using this size trailer for events with 200 people or less. Great for job sites up to 30 employees.

## STANDARD FEATURES

- **Designed to be lowered during install to shorten length of ramp**
- **Self-contained, easy to deploy ramp, sets up quickly**
- Equipped with AC/Heating
- White china toilets with foot flush
- Interior & Exterior LED Lights
- Seamless Gel-coated Fiberglass Walls, Ceiling, and Subfloor
- Oversized Mirrors with Decorative Frames
- Stainless Steel Sinks
- Smart Touch Digital Thermostat



## SPECIFICATIONS

Number of Stations	Womens - 1, Mens - 1, ADA Unisex 1
Box Size	8' 4" x 14' 7"
Length w/ Ramp in Use	25'
Width w/ Ramp in Use	13' 6"
Height w/ AC	12' 6"
Fresh Water Tank	210 Gallons
Waste Tank	300 Gallons
Power Requirements	Two dedicated 120 Volt-20 amp circuit within 100' of the trailer.
No. of AC Units	1

For information on how to reserve this trailer visit  
[theLavatory.com](http://theLavatory.com)

California Locations -  
(559) 382-0982 & (209) 202-3741

Arizona - (602) 598-1331  
Utah - (801) 735-3009

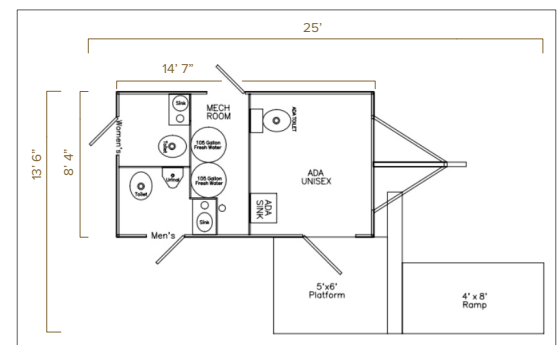

**Ask about our  
SPECIAL RATES  
for weekday  
& long term  
rentals!**



# 5 Station Luxury Restroom Trailer

The **5 Station Restroom Trailer** is by far our most popular restroom trailer. Compact while still offering 5 stations makes it small enough to fit into small event spaces with the capacity to handle larger crowds. We recommend using this size trailer for events with 200-500\* people or job sites with 20-50 employees.



**Ask about our  
SPECIAL RATES  
for weekday  
& long term  
rentals!**

## STANDARD FEATURES

- **WOMEN'S** - 3 stalls, 2 sinks
- **MEN'S** - 1 stall, 1 urinal, 1 sink
- Equipped with AC/Heating
- On Board Water Tanks
- Fully Stocked with Supplies
- Interior & Exterior LED Lights
- Self Leveling Stairs with Platforms & Railings
- Seamless Gel-coated Fiberglass Walls, Ceiling, and Subfloor
- Oversized Mirrors with Decorative Frames
- Stainless Steel Sinks
- Smart Touch Digital Thermostat

## SPECIFICATIONS

Number of Stations	Womens - 3, Mens - 2
Box Size	14'6" x 8' 5"
Length w/ tongue	19'10"
Width w/ Stairs	12'4"
Height w/ AC	11'7"
Fresh Water Tank	200 Gallons
Waste Tank	520 Gallons
Power Requirements	One dedicated 120 Volt-20 amp circuit within 100' of the trailer.
No. of AC Units	1

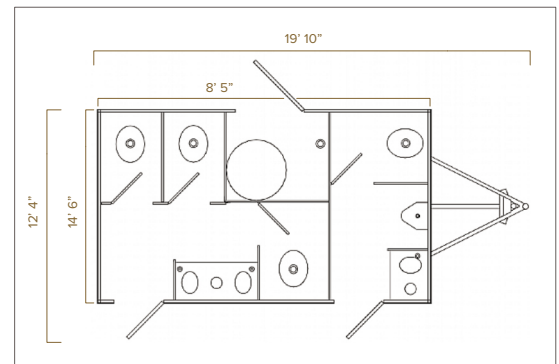

For information on how to reserve this trailer visit  
[theLavatory.com](http://theLavatory.com)

California Locations - (559) 382-0982 & (209) 202-3741  
 Arizona - (602) 598-1331  
 Utah - (801) 735-3009

\*These estimations are based on a 5 hour event. If your event is serving alcoholic beverages these estimations will be on the lower end.



The **9 Station Restroom Trailer** is a versatile, large size restroom trailer that is equipped to handle a variety of large amounts of users for events, remodels, and temporary uses. We recommend using this size trailer for events with 400 to 900\* people or job sites with more than 50 employees.



## STANDARD FEATURES

- **WOMEN'S** - 5 stalls, 2 sinks
- **MEN'S** - 2 stalls, 2 urinals, 1 sink
- Onboard water tank
- Equipped with AC/Heating
- White china toilets with foot flush
- Interior & Exterior LED Lights
- Self Leveling Stairs with Platforms & Railings
- Seamless Gel-coated Fiberglass Walls, Ceiling, and Subfloor
- Oversized Mirrors with Decorative Frames
- Stainless Steel Sinks
- Smart Touch Digital Thermostat (x2)

Ask about our  
**SPECIAL RATES**  
for weekday  
& long term  
rentals!

## SPECIFICATIONS

Number of Stations	Womens - 5, Mens - 4
Box Size	8' 5" x 21"
Length w/ tongue	26' 4"
Width w/ Stairs	12' 4"
Height w/ AC	11' 10"
Fresh Water Tank	200 Gallons
Waste Tank	750 Gallons
Power Requirements	Two dedicated 120 Volt-20 amp circuit within 100' of the trailer.
No. of AC Units	2

For information on how to reserve this trailer visit

[theLavatory.com](http://theLavatory.com)

California Locations -  
(559) 382-0982 & (209) 202-3741

Arizona - (602) 598-1331  
Utah - (801) 735-3009

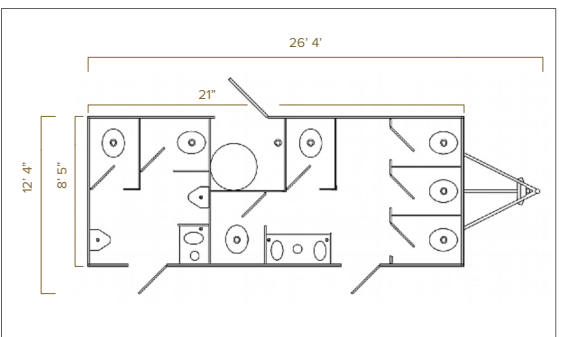

\* These estimations are based on a 5 hour event. If your event is serving alcoholic beverages these estimations will be on the lower end.



**ADA Shower & Restroom Combo** is a great solution to make sure your site fulfills the needs/requirements for ADA users. This trailer is compact and private. The unit meets ADA requirements for both shower and toilet needs. This trailer selection is popular for homeless outreach and elderly centers.

## STANDARD FEATURES

- Equipped with AC/Heating
- Designed to be lowered during install to shorten length of ramp
- Self-contained, easy to deploy ramp, sets up quickly
- ADA China toilet with handle bars
- ADA Shower with seat and wand
- ADA Sink
- Hot and cold water controls
- Shower heads metered to 1.5 gpm
- Large vanity
- Seamless Gel-coated Fiberglass Walls, Ceiling, and Subfloor
- Smart Touch Digital Thermostat

Ask about our  
**SPECIAL RATES**  
for weekday  
& long term  
rentals!



## SPECIFICATIONS

Number of Stations	1
Box Size	8' 5" x 14.5'
Length w/ tongue	25'
Width w/ Stairs	13' 6"
Fresh Water Tank	105 Gallons
Waste Tank	300 Gallons
Power Requirements	2 dedicated 120 Volt-20 amp circuits
No. of AC Units	1

For information on how to reserve this trailer visit  
[theLavatory.com](http://theLavatory.com)

California Locations -  
(559) 382-0982 & (209) 202-3741

Arizona - (602) 598-1331  
Utah - (801) 735-3009

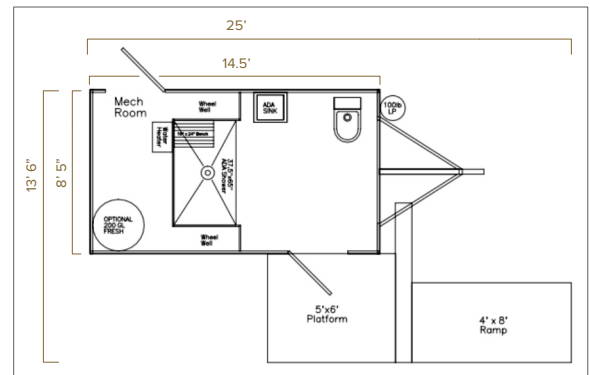

The **2 Station Restroom & Shower Combo Trailer** is a great compact unit that fits well into most event spaces. We recommend using this size trailer for events with 150 people or less. This trailer is a great option for worksites, schools, and remodels. Ideal for jobsites with 20 employees or less.



## STANDARD FEATURES

- Each Private Bathroom has 1 toilet, 1 sink, 1 shower
- Equipped with AC/Heating
- White china toilets with foot flush
- Interior & Exterior LED Lights
- Hot and cold water controls
- Shower heads metered to 1.5 gpm
- Seamless Gel-coated Fiberglass Walls, Ceiling, and Subfloor
- Oversized Mirrors with Decorative Frames
- Stainless Steel Sinks
- Smart Touch Digital Thermostat

Ask about our **SPECIAL RATES** for weekday & long term rentals!

## SPECIFICATIONS

Number of Stations	2
Box Size	7' 7" x 11'
Length w/ tongue	17'
Width w/ Stairs	11' 7"
Fresh Water Tank	105 Gallons
Waste Tank	300 Gallons
Power Requirements	2 dedicated 120 Volt-20 amp circuits
No. of AC Units	1

For information on how to reserve this trailer visit [theLavatory.com](http://theLavatory.com)

California Locations - (559) 382-0982 & (209) 202-3741  
 Arizona - (602) 598-1331  
 Utah - (801) 735-3009

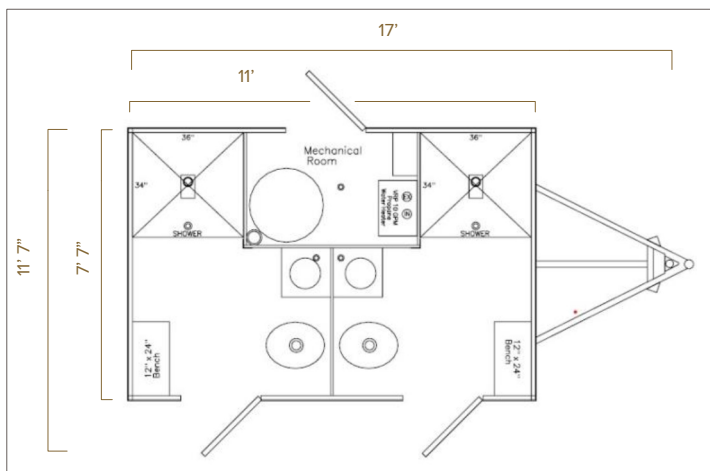



# 8 Station Private Shower Trailer

The **8 Station Private Shower Trailer** contains 8 private shower cabins which allows personal security and easy cleaning compared to most shower trailers. The unit is also equipped with 4 community sink hand washing stations on the exterior of the trailer. Useful for festivals, disaster relief, homeless camps, and other temporary sites.



**Ask about our  
SPECIAL RATES  
for weekday  
& long term  
rentals!**

## STANDARD FEATURES

- 8 Completely private rooms
- Hot and cold water controls
- Shower heads metered to 1.5 gpm
- Can be connected to onsite septic
- CAL Fire approved
- Equipped with AC/Heating
- Seamless Gel-coated Fiberglass Walls, Ceiling, and Subfloor
- Smart Touch Digital Thermostat (x2)

## SPECIFICATIONS

Number of Stations	8 Private cabins + exterior 4 sink hand wash station
Box Size	8' 5" x 29'
Length w/ tongue	35'
Width w/ Stairs	12' 4"
Height w/ AC	11' 10"
Onboard water tank	200 Gallons
Waste Tank	950 Gallons
Power Requirements	One 50amp 220V circuit within 100' of the trailer.
No. of AC Units	2

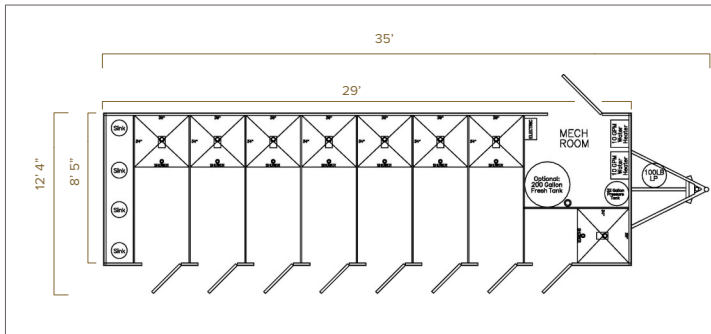

For information on how to reserve this trailer visit  
[theLavatory.com](http://theLavatory.com)

California Locations -  
(559) 382-0982 & (209) 202-3741

Arizona - (602) 598-1331  
Utah - (801) 735-3009



**The 8 Station Laundry Trailer** is designed to give end users the ability to easily do laundry anywhere, any time, and under nearly any circumstance. Mobile laundry trailers are an excellent resource in a diverse number of industries including disaster relief, oil and gas fields, mining, homeless outreach, special events, and many other instances where quick mobile laundry deployment is needed. The Lavatory mobile laundry units are durable, low maintenance, and end user friendly.



## STANDARD FEATURES

- 8 industrial Whirlpool washer and dryers
- Full range of wash and dry cycles
- Large basin sink
- Folding table
- LED light & HVAC



**Ask about our  
SPECIAL RATES  
for weekday  
& long term  
rentals!**

## SPECIFICATIONS

Number of Stations	8 Washers, 8 Dryers
Box Size	8' 5" x 21'
Length w/ tongue	26' 4"
Width w/ Stairs	12' 4"
Waste Tank	750 Gallons
Power Requirements	2 dedicated 50 Amp – 240 Volt-20 amp circuits
No. of AC Units	2

For information on how to reserve this trailer visit  
[theLavatory.com](http://theLavatory.com)

California Locations -  
(559) 382-0982 & (209) 202-3741  
Arizona - (602) 598-1331  
Utah - (801) 735-3009

